

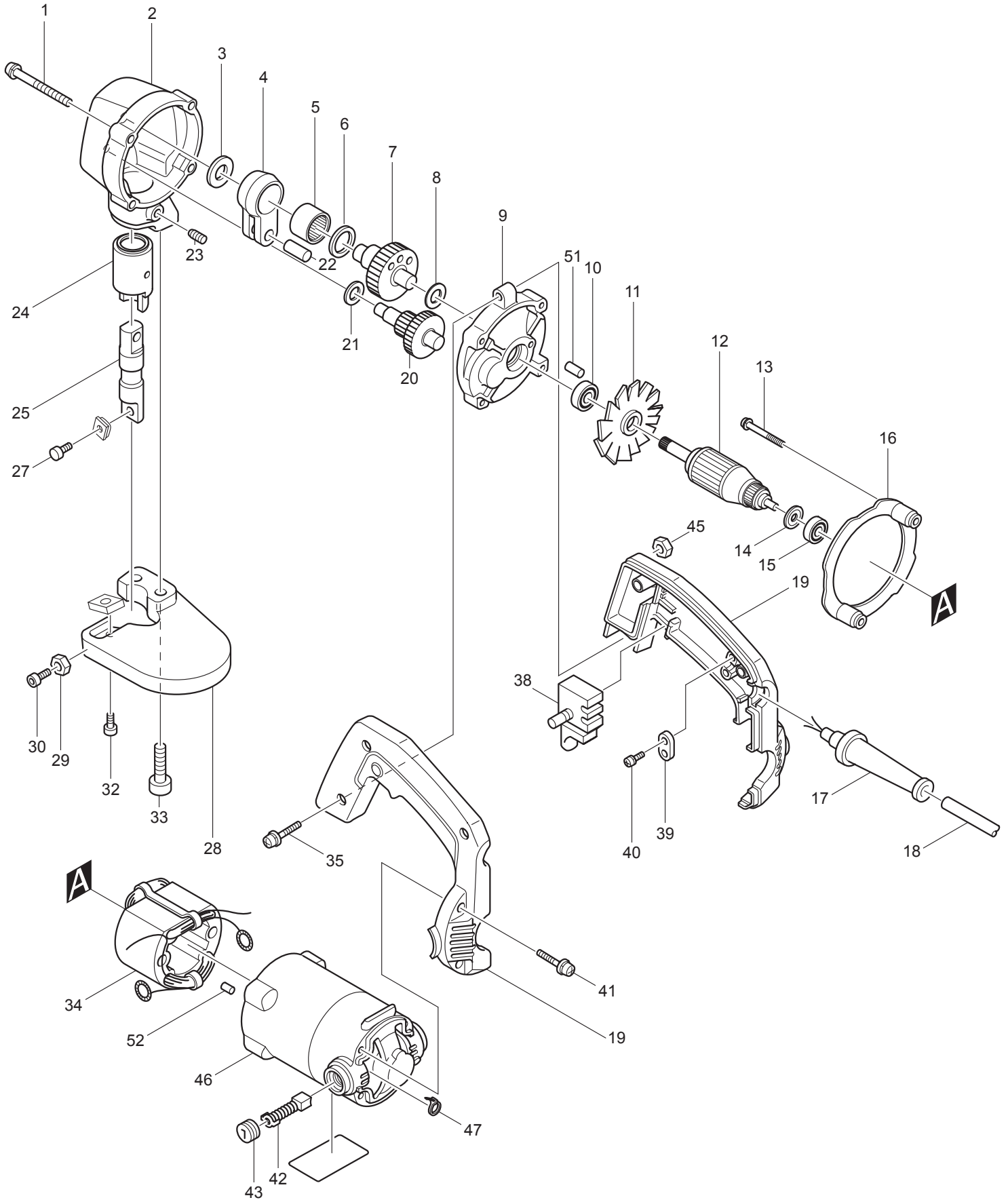

11 - 2010
JS3200
12 GAUGE SHEAR



Item No.	Type	Sub	Part No.	Description	Qty	Unit
1			911266-6	PAN HEAD SCREW M5X45	4	PC.
2	2		157642-2	GEAR HOUSING COMPLETE	1	PC.
		INC.	212104-8	NEEDLE BEARING 1212	1	PC.
		INC.	214001-4	PLANE BEARING 8	1	PC.
3			253759-0	FLAT WASHER 12	1	PC.
4			331166-8	ROD	1	PC.
5			212252-3	NEEDLE BEARING 1816	1	PC.
6			253198-4	FLAT WASHER 18	1	PC.
7			153141-2	CRANK SHAFT COMPLETE	1	PC.
		INC.	221879-8	SPUR GEAR 41	1	PC.
		INC.	254011-9	WOODRUFF KEY 4	1	PC.
8			253758-2	FLAT WASHER 10	1	PC.
9			156833-2	GEAR HOUSING COVER	1	PC.
		INC.	212061-0	NEEDLE BEARING 1010	1	PC.
		INC.	212063-6	NEEDLE BEARING 1012	1	PC.
		INC.		Item No. 51		
10			211033-2	BALL BEARING 608LB	1	PC.
11			241517-6	FAN 70	1	PC.
12	2		512756-8	ARMATURE ASS'Y 115V (OLD# 612756-9)	1	PC.
		INC.		Item No. 10,11,14,15		
13	1		925283-0	PAN HEAD SCREW M5X60	2	PC.
	2		251361-3	PAN HEAD SCREW M5X60 W/GLUE	2	PC.
	3		911681-4	PAN HEAD SCREW M5X60	2	PC.
14			681613-2	INSULATION WASHER	1	PC.
15			211033-2	BALL BEARING 608LB	1	PC.
16			411876-4	BAFFLE PLATE	1	PC.
17			682502-4	CORD GUARD 8-85	1	PC.
18			664064-4	POWER SUPPLY CORD AWG#18-2-2.5	1	PC.
19			181441-0	HANDLE SET	1	SET
20			226058-3	GEAR COMPLETE 18-46	1	PC.
21			253215-0	FLAT WASHER 8	1	PC.
22			256118-7	PIN 8	1	PC.
23			913322-8	SET SCREW M6X14	1	PC.
24			321405-4	METAL	1	PC.
25			321404-6	BLADE HOLDER	1	PC.
27			922216-6	HEX. SOCKET HEAD BOLT M5X14	1	PC.
28			331165-0	YOKE	1	PC.
29			931203-4	HEX. NUT M5	1	PC.
30			922232-8	HEX. SOCKET HEAD BOLT M5X20	1	PC.
32			922216-6	HEX. SOCKET HEAD BOLT M5X14	1	PC.
33			922452-4	HEX. SOCKET HEAD BOLT M8X30	2	PC.
34	1		622551-9	FIELD ASS'Y 115V	1	PC.
		INC.	654501-6	CONNECTOR P-1.25	2	PC.
		INC.	654019-7	RING TERMINAL	2	PC.
34	2		522551-8	FIELD ASS'Y 115V	1	PC.
		INC.	654501-6	CONNECTOR P-1.25	2	PC.
		INC.	654019-7	RING TERMINAL	2	PC.
35			911243-8	PAN HEAD SCREW M5X25	3	PC.
38			651225-5	SWITCH SGEL215C	1	PC.
39			687002-9	STRAIN RELIEF	1	PC.
40	1		911131-9	PAN HEAD SCREW M4X18	2	PC.
	2		911133-5	PAN HEAD SCREW M4X18	2	PC.
41			911243-8	PAN HEAD SCREW M5X25	4	PC.
42	1		191945-4	CARBON BRUSH CB-124 2PC/SET (W/O ORIGIN) - N/L/A	1	SET
	2		194982-7	CARBON BRUSH CB-124 2PC/SET (W/ ORIGIN)	1	SET
42	Opt.1		181038-5	A.C.CARBON BRUSH CB105 2PC/SET (W/O ORIGIN) - N/L/A	1	SET
	Opt.2		194975-4	A.C.CARBON BRUSH CB105 2PC/SET (W/ORIGIN)	1	SET

Item No.	Type	Sub	Part No.	Description	Qty	Unit
43			643600-9	BRUSH HOLDER CAP 6-10	2	PC.
46			156734-4	MOTOR HOUSING	1	PC.
	1	INC.	643603-3	BRUSH HOLDER 6-10 (TYPE1)	2	PC.
	2	INC.	643609-1	BRUSH HOLDER 6-10 (TYPE2)	2	PC.
		INC.		Item No. 52		
47			687010-0	BAND	1	PC.
51			263002-9	RUBBER PIN 4	1	PC.
52			263014-2	RUBBER PIN 4	1	PC.
100			652008-6	P.H.SCREW M3.5X7 (With Washer)	2-4	PC.
101			654037-5	INSULATED EYE TERMINAL FV1.25-M3	2-4	PC.
102			654509-0	CLOSED END CONNECTOR 2-SD	1	PC.
200			819001-5	MAKITA LABEL	1	PC.
<u>ACCESSORIES</u>						
A01			792287-5	SHEAR BLADES SET	1	SET
A02			783202-0	HEX. WRENCH 4	1	PC.
A03			762007-1	THICKNESS GAUGE	1	PC.
A04			181797-1	STEEL CARRYING CASE	1	PC.